

LM48520 Boomer® Audio Power Amplifier Series

Boosted Stereo Class D Audio Power Amplifier with Output Speaker Protection and Spread Spectrum

General Description

The LM48520 integrates a boost converter with a high efficiency Class D stereo audio power amplifier to provide up to 1W/ch continuous power into an 8Ω speaker when operating from 2.7V to 5.0V power supply with boost voltage (PV1) of 5.0V. The LM48520 utilizes a proprietary spread spectrum pulse width modulation technique that lowers RF interference and EMI levels. The Class D amplifier is a low noise, filterless PWM architecture that eliminates the output filter, reducing external component count, board area, power consumption, system cost, and simplifying design.

The LM48520 is designed for use in mobile phones and other portable communication devices. The high (78%) efficiency extends battery life when compared to Boosted Class AB amplifiers. The LM48520 features a low-power consumption shutdown mode. Shutdown may be enabled by driving the Shutdown pin to a logic low (GND). Also, external leakage is minimized via control of the ground reference via the SW-OUT pin.

The LM48520 has 4 gain options which are pin selectable via Gain0 and Gain1 pins. Output short circuit prevents the device from damage during fault conditions. Superior click and pop suppression eliminates audible transients during power-up and shutdown.

Key Specifications

■ Quiescent Power Supply Current	11.5mA (typ)
■ Output Power ($R_L = 8\Omega$, THD+N $\leq 1\%$, $V_{DD} = 3.3V$, PV1 = 5.0V)	1.1W (typ)
■ Shutdown Current	0.04μA (typ)

Features

- Click and Pop Suppression
- Low 0.04μA Shutdown Current
- 78% Efficiency
- Filterless Class D
- 2.7V - 5.0V operation
- 4 Adjustable Gain settings
- Adjustable output swing limiter with Soft Clipping
- Speaker Protection
- Short circuit protection on Audio Amps
- Independent Boost and Amplifier shutdown pins

Applications

- Mobile Phones
- PDAs
- Portable media
- Cameras
- Handheld games

Typical Application

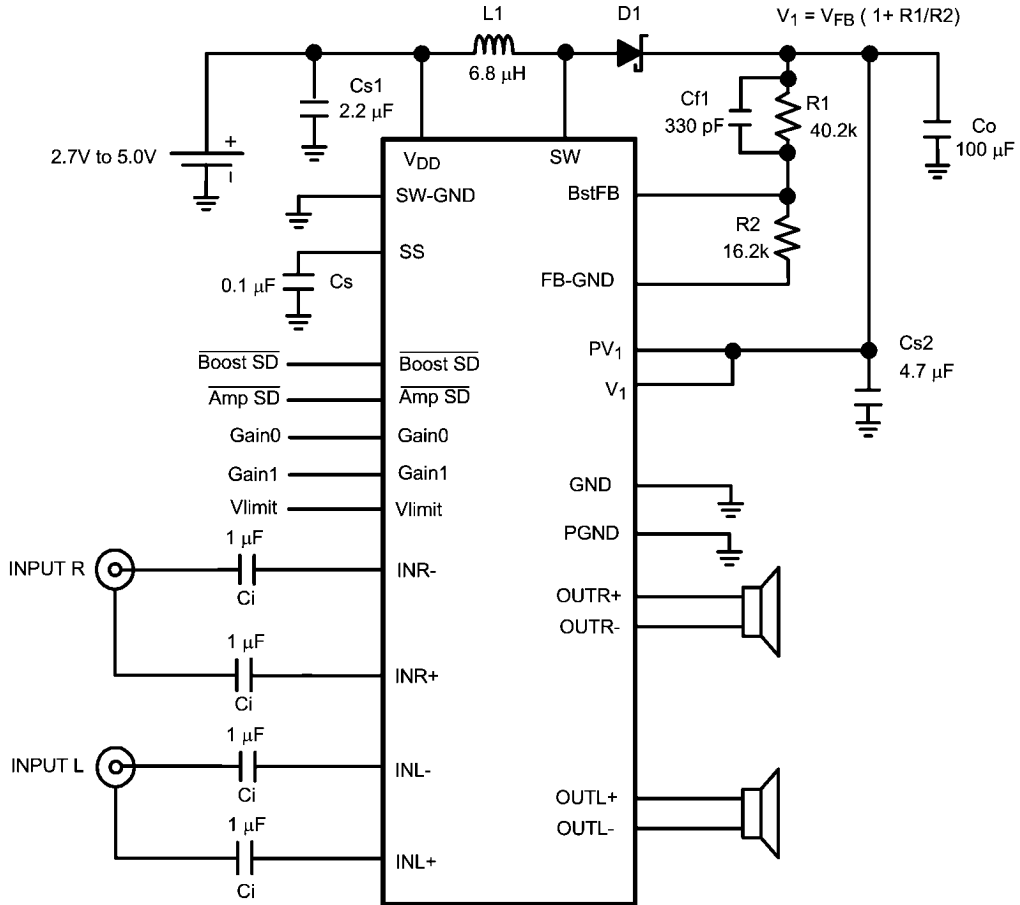

20198701

FIGURE 1. Typical LM48520 Audio Amplifier Application Circuit

Connection Diagrams

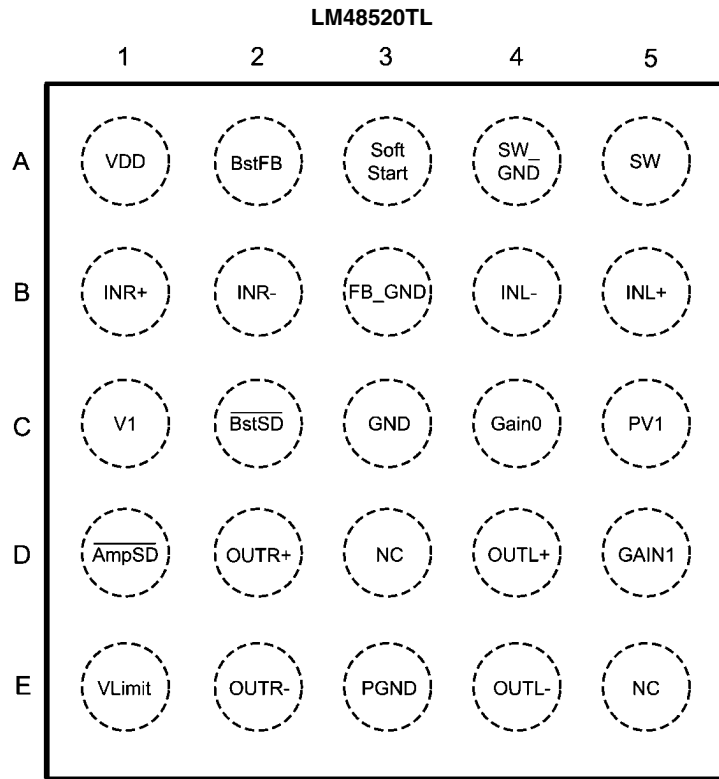

20198702

Top View
Order Number LM48520TL
See NS Package Number TLA25AAA

Micro SMD Marking

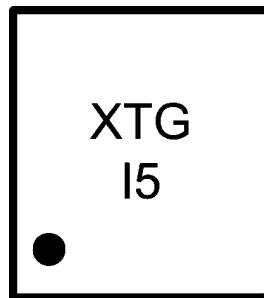

20198721

Top View
X — Date Code
T — Die Traceability
G — Boomer Family
I5 — LM48520TL

Pin Descriptions

Pin Designator	Pin Name	Pin Function
A1	VDD	Power Supply
A2	BstFB	Regulator Feedback Input. Connect BstFB to an external resistive voltage divider to set the boost output voltage.
A3	Soft Start	Soft start capacitor
A4	SW_GND	Booster ground
A5	SW	Drain of the Internal FET switch
B1	INR+	Non-inverting right channel input
B2	INR-	Inverting right channel input
B3	FB_GND	Ground return for R1, R2 resistor divider
B4	INL-	Inverting left channel input
B5	INL+	Non-inverting left channel input
C1	V1	Amplifier supply voltage. Connect to PV1.
C2	BstSD	Regulator active low shutdown
C3	GND	Ground
C4	Gain0	Gain setting input 0
C5	PV1	Amplifier H-bridge power supply. Connect to V1.
D1	AmpSD	Amplifier active low shutdown
D2	OUTR+	Non-inverting right channel output
D3	NC	No connect
D4	OUTL+	Non-inverting left channel output
D5	Gain1	Gain setting input 1
E1	VLimit	Set to control output clipping level
E2	OUTR-	Inverting right channel output
E3	PGND	Power ground
E4	OUTL-	Inverting left channel output
E5	NC	No connect

Absolute Maximum Ratings (Note 2)

If Military/Aerospace specified devices are required, please contact the National Semiconductor Sales Office/ Distributors for availability and specifications.

Supply Voltage (V_{DD} , V_1)	6V
Storage Temperature	-65°C to +150°C
Input Voltage	-0.3V to $V_{DD} + 0.3V$
Power Dissipation (Note 3)	Internally limited
ESD Susceptibility (Note 4)	2000V
ESD Susceptibility (Note 5)	200V
Junction Temperature	150°C

Thermal Resistance

 θ_{JA} (TL)

40.5 °C/W

Operating Ratings

Temperature Range

 $T_{MIN} \leq T_A \leq T_{MAX}$ $-40^\circ\text{C} \leq T_A \leq +85^\circ\text{C}$ Supply Voltage (V_{DD}) $2.7V \leq V_{DD} \leq 5.0V$ Amplifier Voltage (V_1)

Not under Boosted Condition

 $2.4V \leq V_1 \leq 5.5V$

Amplifier Voltage (PV1)

Under Boosted Condition

 $3.0V \leq PV_1 \leq 5.0V$ **Electrical Characteristics $V_{DD} = 3.3V$** (Notes 1, 2)

The following specifications apply for $V_{DD} = 3.3V$, $A_V = 6\text{dB}$, $R_L = 15\mu\text{H} + 8\Omega + 15\mu\text{H}$, $f_{IN} = 1\text{kHz}$, unless otherwise specified. Limits apply for $T_A = 25^\circ\text{C}$, $R_1 = 40.2\text{k}\Omega$, $R_2 = 16.2\text{k}\Omega$, $V_1 = PV_1 = 5V$, $V_{limit} = \text{GND}$. All electrical specifications are for amplifier and booster.

Symbol	Parameter	Conditions	LM48520		Units (Limits)
			Typical (Note 6)	Limit (Notes 7, 8)	
I_{DD}	Quiescent Power Supply Current	$V_{IN} = 0$, $R_{LOAD} = \infty$			
		$V_{DD} = 2.7V$	14.8		
		$V_{DD} = 3.3V$	11.5	15.5	mA (max)
		$V_{DD} = 5.0V$	8.0		
I_{SD}	Shutdown Current	$V_{SHUTDOWN} = \text{GND}$	0.04	1.0	μA (max)
V_{SDIH}	Shutdown Voltage Input High	For SD Boost, SD Amp		1.4	V
V_{SDIL}	Shutdown Voltage Input Low	For SD Boost, SD Amp		0.4	V
T_{WU}	Wake-up Time	Amplifier + Booster Wakeup	3		ms
V_{OS}	Output Offset Voltage		5		mV
A_V	Gain	$G_0, G_1 = \text{GND}$ $R_L = \infty$	6		dB
		$G_0 = V_{DD}$, $G_1 = \text{GND}$ $R_L = \infty$	12		dB
		$G_0 = \text{GND}$, $G_1 = V_{DD}$ $R_L = \infty$	18		dB
		$G_0, G_1 = V_{DD}$ $R_L = \infty$	24		dB
P_O	Output Power	$R_L = 15\mu\text{H} + 8\Omega + 15\mu\text{H}$ THD+N = 1% (max), $f = 1\text{kHz}$, 22kHz, BW $V_{DD} = 3.3V$	1.1	0.87	W (min)
		$R_L = 15\mu\text{H} + 8\Omega + 15\mu\text{H}$ THD+N = 10% (max), $f = 1\text{kHz}$, 22kHz, BW $V_{DD} = 3.3V$	1.3		W
THD+N	Total Harmonic Distortion + Noise	$P_O = 500\text{mW}$, $f = 1\text{kHz}$, $R_L = 15\mu\text{H} + 8\Omega + 15\mu\text{H}$, $V_{DD} = 3.3V$	0.04		%
ϵ_{OS}	Output Noise	$V_{DD} = 3.6V$, $f = 20\text{Hz} - 20\text{kHz}$ Inputs to AC GND, A weighted	32		μV_{RMS}

Symbol	Parameter	Conditions	LM48520		Units (Limits)
			Typical (Note 6)	Limit (Notes 7, 8)	
PSRR	Power Supply Rejection Ratio	$V_{\text{RIPPLE}} = 200\text{mV}_{\text{P-P}}$ Sine, $f_{\text{RIPPLE}} = 217\text{Hz}$	82		dB
		$V_{\text{RIPPLE}} = 200\text{mV}_{\text{P-P}}$ Sine, $f_{\text{RIPPLE}} = 1\text{kHz}$	79		dB
CMRR	Common Mode Rejection Ratio	$V_{\text{RIPPLE}} = 1\text{V}_{\text{P-P}}$, $f_{\text{RIPPLE}} = 217\text{Hz}$	67		dB
η	Efficiency	$P_{\text{O}} = 1\text{W}$, $f = 1\text{kHz}$, $R_{\text{L}} = 15\mu\text{H} + 8\Omega + 15\mu\text{H}$ $V_{\text{DD}} = 3.3\text{V}$ $V_{\text{DD}} = 4.2\text{V}$	78		%
V_{FB}	Feedback Pin Reference Voltage	(Note 11)	1.24		V
$V_{\text{out clipped}}$	Output Voltage in clipped state with soft clip activated	$V_{\text{limit}} = 2\text{V}$, $R_{\text{L}} = 8\Omega$, $V_{\text{IN}} = 2V_{\text{P}}$ $V_{\text{out clipped}} = 8/3 (PV1 - 2V_{\text{limit}})$	2.5	1.9 3.2	Vpk (min) Vpk (max)

Note 1: All voltages are measured with respect to the GND pin, unless otherwise specified.

Note 2: *Absolute Maximum Ratings* indicate limits beyond which damage to the device may occur. *Operating Ratings* indicate conditions for which the device is functional, but do not guarantee specific performance limits. *Electrical Characteristics* state DC and AC electrical specifications under particular test conditions which guarantee specific performance limits. This assumes that the device is within the Operating Ratings. Specifications are not guaranteed for parameters where no limit is given, however, the typical value is a good indication of device performance.

Note 3: The maximum power dissipation must be derated at elevated temperatures and is dictated by T_{JMAX} , θ_{JA} , and the ambient temperature, T_{A} . The maximum allowable power dissipation is $P_{\text{DMAX}} = (T_{\text{JMAX}} - T_{\text{A}}) / \theta_{\text{JA}}$ or the given in Absolute Maximum Ratings, whichever is lower.

Note 4: Human body model, 100pF discharged through a 1.5k Ω resistor.

Note 5: Machine Model, 220pF–240pF discharged through all pins.

Note 6: Typical values are measured at 25°C and represent the parametric norm.

Note 7: Limits are guaranteed to National's AOQL (Average Outgoing Quality Level).

Note 8: Datasheet min/max specification limits are guaranteed by design, test, or statistical analysis.

Note 9: Shutdown current is measured in a normal room environment. The Shutdown pin should be driven as close as possible to V_{in} for minimum shutdown current.

Note 10: Shutdown current is measured with components R1 and R2 removed.

Note 11: Feedback pin reference voltage is measured with the Audio Amplifier disconnected from the Boost converter (the Boost converter is unloaded).

Typical Performance Characteristics

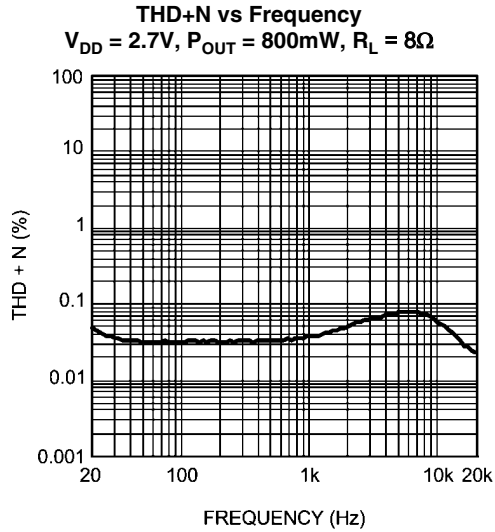

20198703

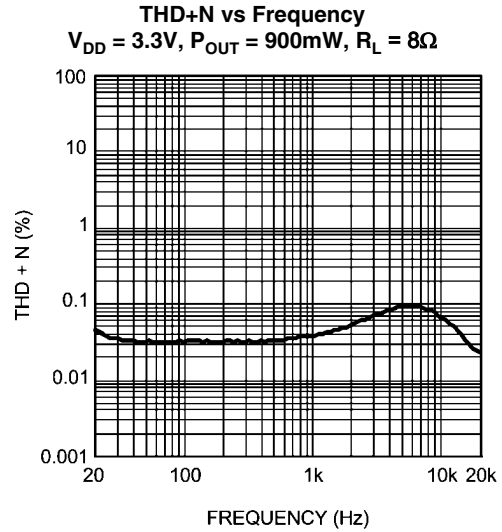

20198704

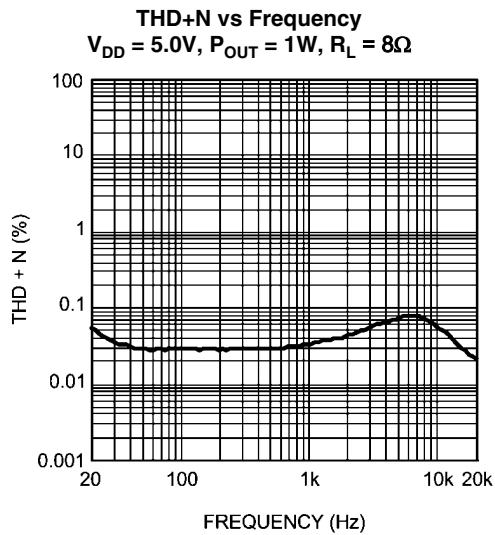

20198705

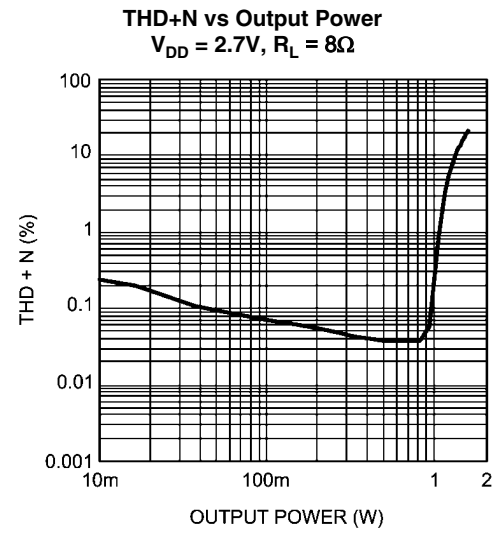

20198706

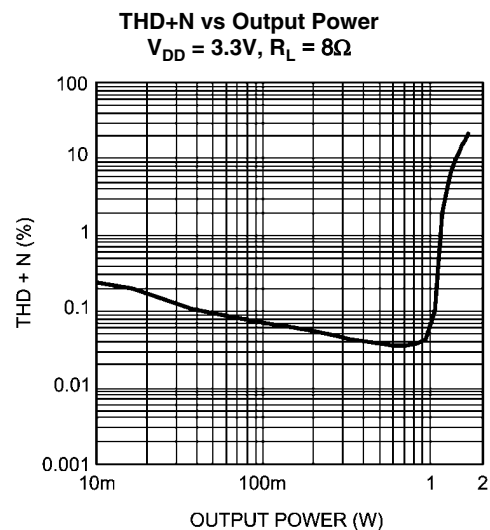

20198707

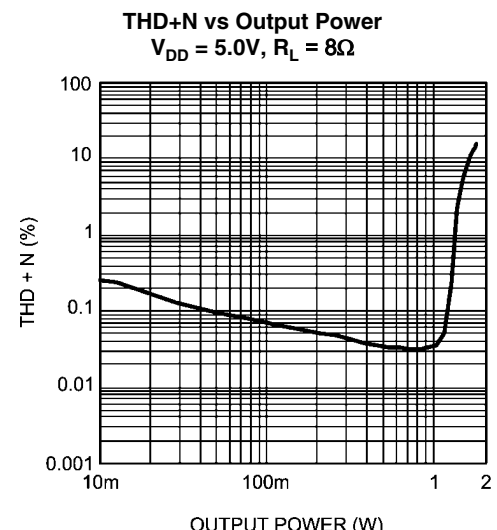

20198708

Power Dissipation vs Output Power
 $V_{DD} = 2.7V, R_L = 8\Omega, f = 1kHz$

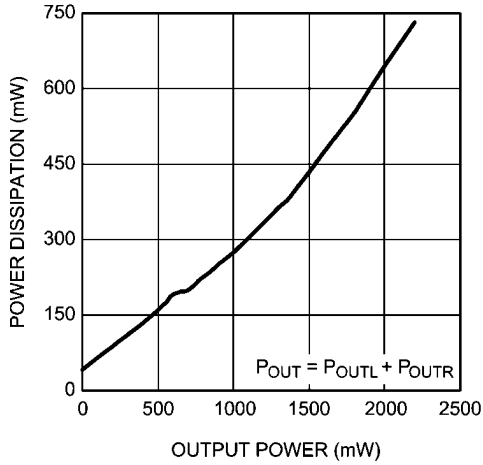

20198712

Power Dissipation vs Output Power
 $V_{DD} = 3.3V, R_L = 8\Omega, f = 1kHz$

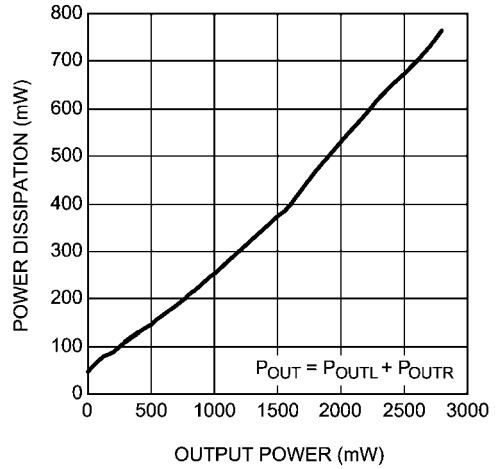

20198713

Power Dissipation vs Output Power
 $V_{DD} = 5.0V, R_L = 8\Omega, f = 1kHz$

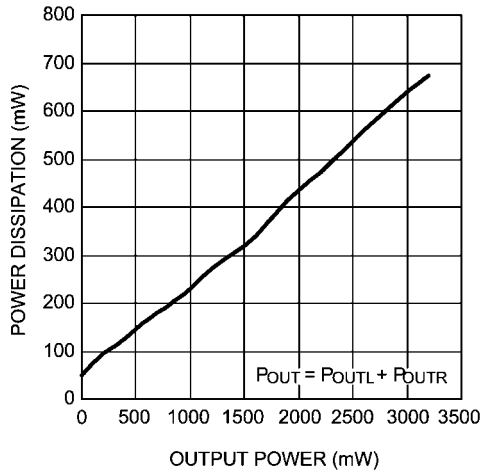

20198714

Efficiency vs Output Power
 $V_{DD} = 2.7V, R_L = 8\Omega, f = 1kHz$

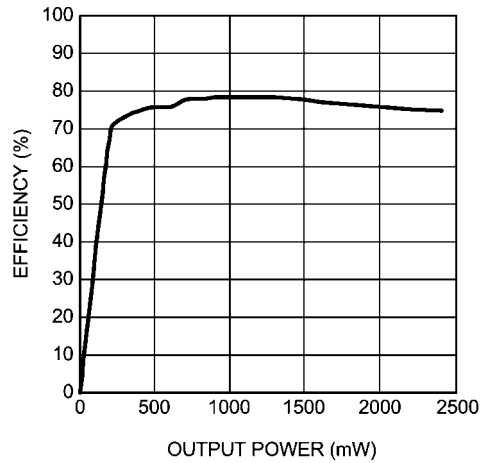

20198709

Efficiency vs Output Power
 $V_{DD} = 3.3V, R_L = 8\Omega, f = 1kHz$

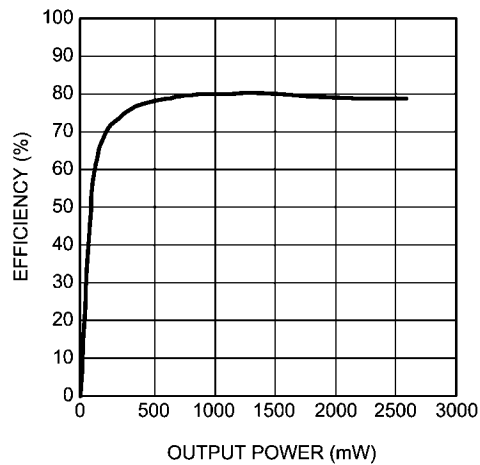

20198710

Efficiency vs Output Power
 $V_{DD} = 5.0V, R_L = 8\Omega, f = 1kHz$

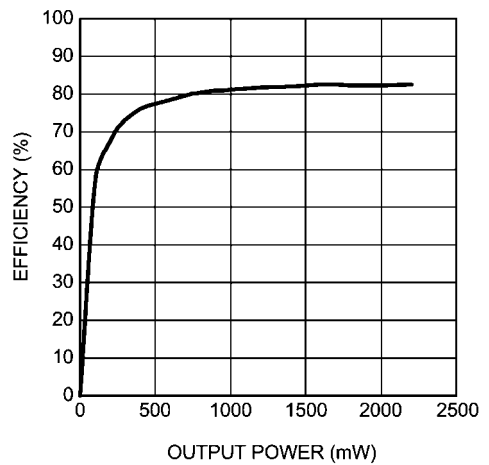

20198711

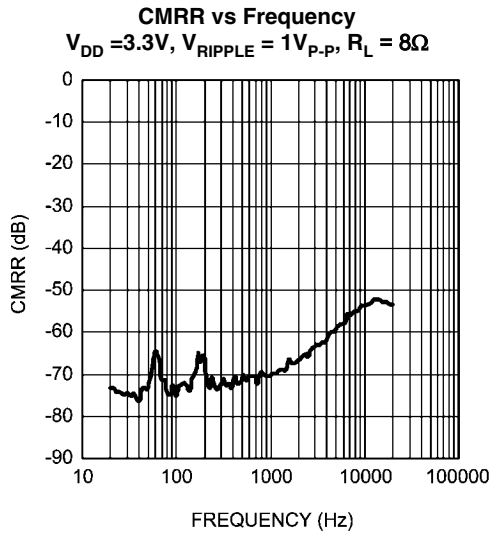

20198722

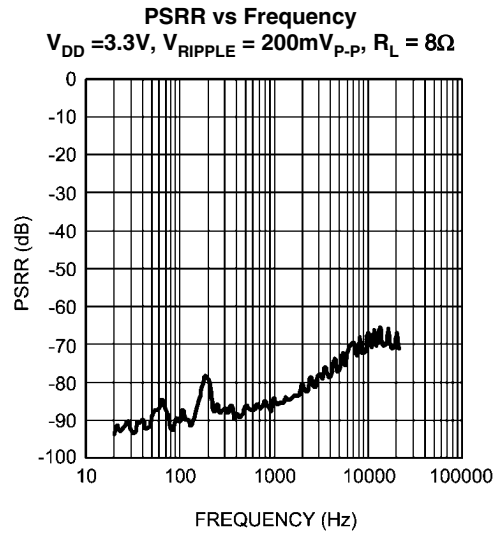

20198723

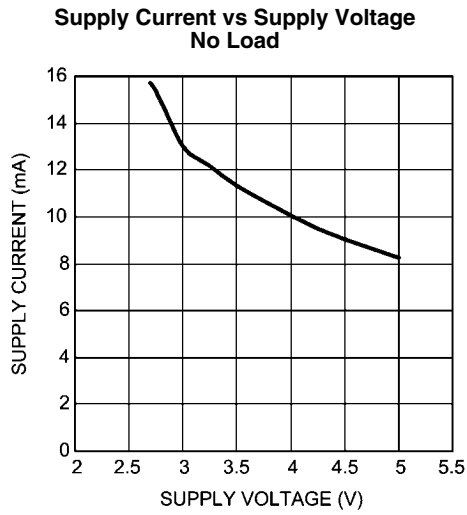

20198724

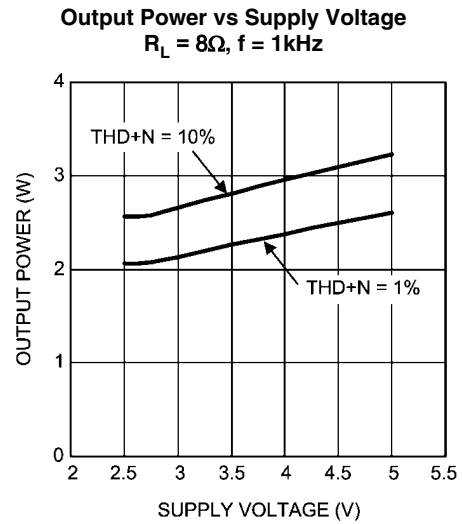

20198725

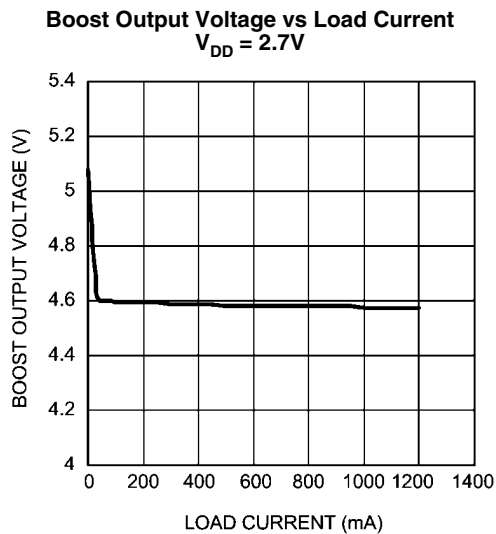

20198726

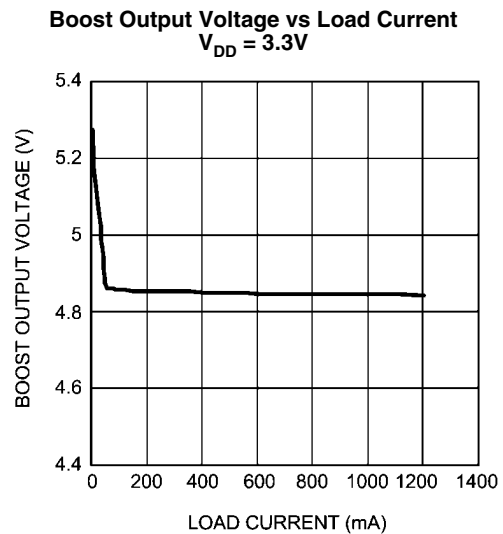

20198727

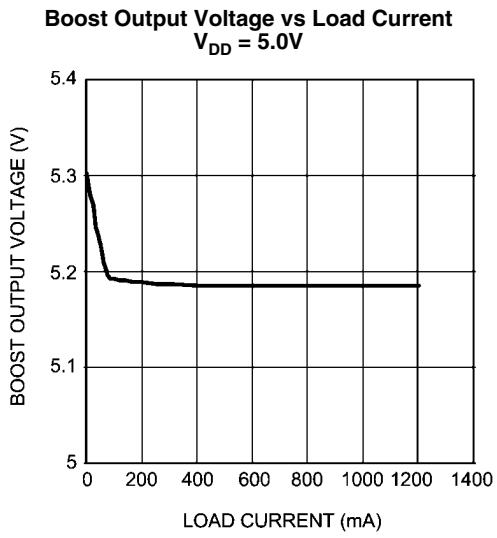

20198728

Application Information

GENERAL AMPLIFIER FUNCTION

The LM48520 features a Class D audio power amplifier that utilizes a filterless modulation scheme, reducing external component count, conserving board space and reducing system cost. The outputs of the device transition from PV1 to GND with a 300kHz switching frequency. With no signal applied, the outputs (V_{LS+} and V_{LS-}) switch with a 50% duty cycle, in phase, causing the two outputs to cancel. This cancellation results in no net voltage across the speaker, thus there is no current to the load in the idle state.

With the input signal applied, the duty cycle (pulse width) of the LM48520 outputs changes. For increasing output voltage, the duty cycle of V_{LS+} increases, while the duty cycle of V_{LS-} decreases. For decreasing output voltages, the converse occurs. The difference between the two pulse widths yields the differential output voltage.

DIFFERENTIAL AMPLIFIER EXPLANATION

The amplifier portion of the LM48520 is a fully differential amplifier that features differential input and output stages. A differential amplifier amplifies the difference between the two input signals. Traditional audio power amplifiers have typically offered only single-ended inputs resulting in a 6dB reduction in signal to noise ratio relative to differential inputs. The amplifier also offers the possibility of DC input coupling which eliminates the two external AC coupling, DC blocking capacitors. The amplifier can be used, however, as a single ended input amplifier while still retaining its fully differential benefits. In fact, completely unrelated signals may be placed on the input pins. The amplifier portion of the LM48520 simply amplifies the difference between the signals. A major benefit of a differential amplifier is the improved common mode rejection ratio (CMRR) over single input amplifiers. The common-mode rejection characteristic of the differential amplifier reduces sensitivity to ground offset related noise injection, especially important in high noise applications.

AMPLIFIER DISSIPATION AND EFFICIENCY

The major benefit of a Class D amplifier is increased efficiency versus a Class AB. The efficiency of the LM48520 is attributed to the region of operation of the transistors in the output stage. The Class D output stage acts as current steering switches, consuming negligible amounts of power compared to their Class AB counterparts. Most of the power loss associated with the output stage is due to the IR loss of the MOSFET on-resistance, along with switching losses due to gate charge.

REGULATOR POWER DISSIPATION

At higher duty cycles, the increased ON-time of the switch FET means the maximum output current will be determined by power dissipation within the LM48520 FET switch. The switch power dissipation from ON-time conduction is calculated by:

$$P_{D(SWITCH)} = DC \times (I_{INDUCTOR(AVE)})^2 \times R_{DS(ON)} \quad (W) \quad (1)$$

Where DC is the duty cycle.

SHUTDOWN FUNCTION

The LM48520 features independent amplifier and regulator shutdown controls, allowing each portion of the device to be disabled or enabled independently. \overline{AmpSD} controls the

Class D amplifiers, while \overline{BstSD} controls the regulator. Driving either inputs low disables the corresponding portion of the device, and reducing supply current.

When the regulator is disabled, both FB_GND switches open, further reducing shutdown current by eliminating the current path to GND through the regulator feedback network. With the regulator disabled, there is still a current path from V_{DD} , through the inductor and diode, to the amplifier power supply. This allows the amplifier to operate even when the regulator is disabled. The voltage at PV1 and V1 will be:

$$V_{DD} - [V_D + (I_L \times DCR)] \quad (2)$$

Where V_D is the forward voltage of the Schottky diode, I_L is the current through the inductor, and DCR is the DC resistance of the inductor. Additionally, when the regulator is disabled, an external voltage between 2.4V and 5.5V can be applied directly to PV1 and V1 to power the amplifier.

It is best to switch between ground and V_{DD} for minimum current consumption while in shutdown. The LM48520 may be disabled with shutdown voltages in between GND and V_{DD} , the idle current will be greater than the typical 0.1 μ A value. Increased THD+N may also be observed when a voltage of less than V_{DD} is applied to \overline{AmpSD} .

PROPER SELECTION OF EXTERNAL COMPONENTS

Proper selection of external components in applications using integrated power amplifiers, and switching DC-DC converters, is critical for optimizing device and system performance. Consideration to component values must be used to maximize overall system quality.

The best capacitors for use with the switching converter portion of the LM48520 are multi-layer ceramic capacitors. They have the lowest ESR (equivalent series resistance) and highest resonance frequency, which makes them optimum for high frequency switching converters.

When selecting a ceramic capacitor, only X5R and X7R dielectric types should be used. Other types such as Z5U and Y5F have such severe loss of capacitance due to effects of temperature variation and applied voltage, they may provide as little as 20% of rated capacitance in many typical applications. Always consult capacitor manufacturer's data curves before selecting a capacitor. High-quality ceramic capacitors can be obtained from Taiyo-Yuden, AVX, and Murata.

POWER SUPPLY BYPASSING FOR AMPLIFIER

As with any amplifier, proper supply bypassing is critical for low noise performance and high power supply rejection. The capacitor location on both PV1, V1 and V_{DD} pins should be as close to the device as possible.

SELECTING INPUT CAPACITOR FOR AUDIO AMPLIFIER

Input capacitors, C_{IN} , in conjunction with the input impedance of the LM48520 forms a high pass filter that removes the DC bias from an incoming signal. The AC-coupling capacitor allows the amplifier to bias the signal to an optimal DC level. Assuming zero source impedance, the -3dB point of the high pass filter is given by:

$$f_{(-3dB)} = 1/2\pi R_{IN} C_{IN} \quad (3)$$

Choose C_{IN} such that f_{-3dB} is well below that lowest frequency of interest. Setting f_{-3dB} too high affects the low-frequency responses of the amplifier. Use capacitors with low voltage

coefficient dielectrics, such as tantalum or aluminum electrolytic. Capacitors with high-voltage coefficients, such as ceramics, may result in increased distortion at low frequencies. Other factors to consider when designing the input filter include the constraints of the overall system. Although high fidelity audio requires a flat frequency response between 20Hz and 20kHz, portable devices such as cell phones may only concentrate on the frequency range of the frequency range of the spoken human voice (typically 300Hz to 4kHz). In addition, the physical size of the speakers used in such portable devices limits the low frequency response; in this case, frequencies below 150Hz may be filtered out.

SELECTING OUTPUT CAPACITOR (C_O) FOR BOOST CONVERTER

A single 100 μ F low ESR tantalum capacitor provides sufficient output capacitance for most applications. Higher capacitor values improve line regulation and transient response. Typical electrolytic capacitors are not suitable for switching converters that operate above 500kHz because of significant ringing and temperature rise due to self-heating from ripple current. An output capacitor with excessive ESR reduces phase margin and causes instability.

SELECTING INPUT CAPACITOR (C_{S1}) FOR BOOST CONVERTER

An input capacitor is required to serve as an energy reservoir for the current which must flow into the coil each time the switch turns ON. This capacitor must have extremely low ESR, so ceramic is the best choice. We recommend a nominal value of 2.2 μ F, but larger values can be used. Since this capacitor reduces the amount of voltage ripple seen at the input pin, it also reduces the amount of EMI passed back along that line to other circuitry.

SELECTING SOFTSTART (C_{SS}) CAPACITOR

The soft-start function charges the boost converter reference voltage slowly. This allows the output of the boost converter to ramp up slowly thus limiting the transient current at startup. Selecting a soft-start capacitor (C_{SS}) value presents a trade off between the wake-up time and the startup transient current. Using a larger capacitor value will increase wake-up time and decrease startup transient current while the opposite effect happens with a smaller capacitor value. A general guideline is to use a capacitor value 1000 times smaller than the output capacitance of the boost converter (C_O). A 0.1 μ F soft-start capacitor is recommended for a typical application.

SETTING THE OUTPUT VOLTAGE (V_I) OF BOOST CONVERTER

The output voltage is set using the external resistors R1 and R2 (see Figure 1). A value of approximately 13.3k Ω is recommended for R2 to establish a divider current of approximately 92 μ A. R1 is calculated using the formula:

$$R1 = R2 \times (V_I / 1.23 - 1) \quad (4)$$

FEED-FORWARD COMPENSATION FOR BOOST CONVERTER

Although the LM48520's internal Boost converter is internally compensated, the external feed-forward capacitor C_f is required for stability (see Figure 1). Adding this capacitor puts a zero in the loop response of the converter. The recommended frequency for the zero f_z should be approximately 6kHz. C_{f1} can be calculated using the formula:

$$C_f = 1 / (2 \times R1 \times f_z) \quad (5)$$

SELECTING DIODES FOR BOOST

The external diode used in Figure 1 should be a Schottky diode. A 20V diode such as the MBRS320T3 is recommended.

The MBRS320T3 series of diodes are designed to handle a maximum average current of 3A.

DUTY CYCLE

The maximum duty cycle of the boost converter determines the maximum boost ratio of output-to-input voltage that the converter can attain in continuous mode of operation. The duty cycle for a given boost application is defined as:

$$\text{Duty Cycle} = \frac{V_{OUT} + V_{DIODE} - V_{IN}}{V_{OUT} + V_{DIODE} - V_{SW}}$$

This applies for continuous mode operation.

SELECTING INDUCTOR VALUE

Inductor value involves trade-offs in performance. Larger inductors reduce inductor ripple current, which typically means less output voltage ripple (for a given size of output capacitor). Larger inductors also mean more load power can be delivered because the energy stored during each switching cycle is:

$$E = L/2 \times (I_p)^2$$

Where " I_p " is the peak inductor current. The LM48520 will limit its switch current based on peak current. With I_p fixed, increasing L will increase the maximum amount of power available to the load. Conversely, using too little inductance may limit the amount of load current which can be drawn from the output. Best performance is usually obtained when the converter is operated in "continuous" mode at the load current range of interest, typically giving better load regulation and less output ripple. Continuous operation is defined as not allowing the inductor current to drop to zero during the cycle. Boost converters shift over to discontinuous operation if the load is reduced far enough, but a larger inductor stays continuous over a wider load current range.

During the TBD μ s ON-time, the inductor current ramps up TBDA and ramps down an equal amount during the OFF-time. This is defined as the inductor "ripple current". It can also be seen that if the load current drops to about TBDmA, the inductor current will begin touching the zero axis which means it will be in discontinuous mode. A similar analysis can be performed on any boost converter, to make sure the ripple current is reasonable and continuous operation will be maintained at the typical load current values.

MAXIMUM SWITCH CURRENT

The maximum FET switch current available before the current limiter cuts in is dependent on duty cycle of the application. This is illustrated in a graph in the typical performance characterization section which shows typical values of switch current as a function of effective (actual) duty cycle.

CALCULATING OUTPUT CURRENT OF BOOST CONVERTER (I_{AMP})

As shown in Figure 2 which depicts inductor current, the load current is related to the average inductor current by the relation:

$$I_{LOAD} = I_{IND}(AVG) \times (1 - DC) \quad (6)$$

Where "DC" is the duty cycle of the application. The switch current can be found by:

$$I_{SW} = I_{IND}(AVG) + 1/2 (I_{RIPPLE}) \quad (7)$$

Inductor ripple current is dependent on inductance, duty cycle, input voltage and frequency:

$$I_{RIPPLE} = DC \times (V_{IN} - V_{SW}) / (f \times L) \quad (8)$$

combining all terms, we can develop an expression which allows the maximum available load current to be calculated:

$$I_{LOAD(max)} = (1 - DC) \times (I_{SW(max)} - DC(V_{IN} - V_{SW})) / fL \quad (9)$$

The equation shown to calculate maximum load current takes into account the losses in the inductor or turn-OFF switching losses of the FET and diode.

DESIGN PARAMETERS V_{SW} AND I_{SW}

The value of the FET "ON" voltage (referred to as V_{SW} in equations 4 thru 7) is dependent on load current. A good approximation can be obtained by multiplying the "ON Resistance" of the FET times the average inductor current.

FET on resistance increases at V_{IN} values below 5V, since the internal N-FET has less gate voltage in this input voltage range (see Typical Performance Characteristics curves). Above $V_{IN} = 5V$, the FET gate voltage is internally clamped to 5V.

The maximum peak switch current the device can deliver is dependent on duty cycle. For higher duty cycles, see Typical Performance Characteristics curves.

INDUCTOR SUPPLIERS

The recommended inductor for the LM48520 is the NR8040T6R8N from Taiyo Yuden. When selecting an induc-

tor, make certain that the continuous current rating is high enough to avoid saturation at peak currents, where:

$$I_{IND} = (PV1 / V_{DD}) \times I_{LOAD(BOOST)} \quad (10)$$

A suitable core type must be used to minimize core (switching) losses, and wire power losses must be considered when selecting the current rating.

PCB Layout Guidelines

High frequency boost converters require very careful layout of components in order to get stable operation and low noise.

All components must be as close as possible to the LM48520 device. It is recommended that a four layer PCB be used so that internal ground planes are available.

Some additional guidelines to be observed (all designators are referencing Figure 1):

1. Keep the path between L1, D1, and Co extremely short. Parasitic trace inductance in series with D1 and Co will increase noise and ringing.
2. The feedback components R1, R2 and Cf1 must be kept close to the FB pin to prevent noise injection on the FB pin trace.
3. Since the external components of the boost converter are switching, L1 and D1 should be kept away from the input traces to prevent the noise from injecting into the input.
4. The power supply bypass capacitors, Cs1 and Cs2 should be placed as close to the LM48520 device as possible.

GROUNDING GUIDELINES

There are three grounds on the LM48520, GND, SW_GND, and PGND. When laying out the PCB, it is critical to connect the grounds as close to the device as possible. The simplest way to do that is to place vias close to the GND, SW_GND, and PGND bumps and connect the GND, SW_GND, and PGND vias using a single ground plane in an inner layer of the PCB.

Output Speaker Protection Function

The LM48520's output voltage limiter can be used to set a minimum and maximum output voltage swing magnitude. The voltage applied to the VLimit pin controls the limit on the output voltage level. The output level is determined by the following equation:

$$V_{out\ clipped} = 8/3 * (PV1 - 2 * V_{limit})$$

or

$$V_{out\ clipped} = 1/2 * (PV1 - 3/8 * V_{out\ clipped})$$

Where, $V_{out\ clipped}$ = the desired output level measured in V_{pk} , $PV1$ = Boost output voltage, and V_{limit} is the voltage applied to the VLimit pin on the LM48520.

To disable the limiter, set $V_{limit} = 0V$.

Figure 2 provides an example of how the output voltage limiter functions with $V_{DD} = 3.3V$, $A_V = 6dB$, $PV1 = 5V$, $V_{limit} = 2V$, $R_L = 8\Omega$, $V_{IN} = 2V_P$.

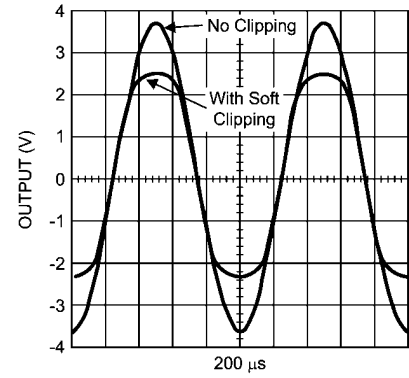

20198729

FIGURE 2. Soft Clipping vs No Clipping

Revision History

Rev	Date	Description
1.0	02/27/08	Initial release.
1.01	03/07/08	Added the Soft clipping vs No clipping curve.
1.02	03/12/08	Text edits.

Physical Dimensions inches (millimeters) unless otherwise noted

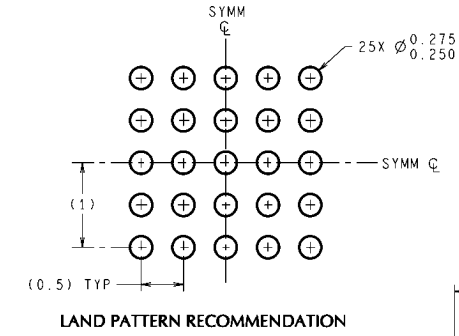

LAND PATTERN RECOMMENDATION

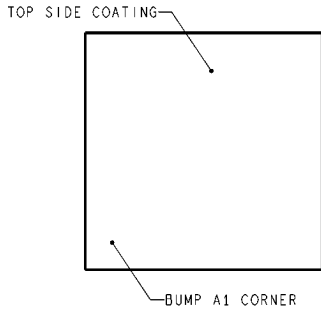

DIMENSIONS ARE IN MILLIMETERS
DIMENSIONS IN () FOR REFERENCE ONLY

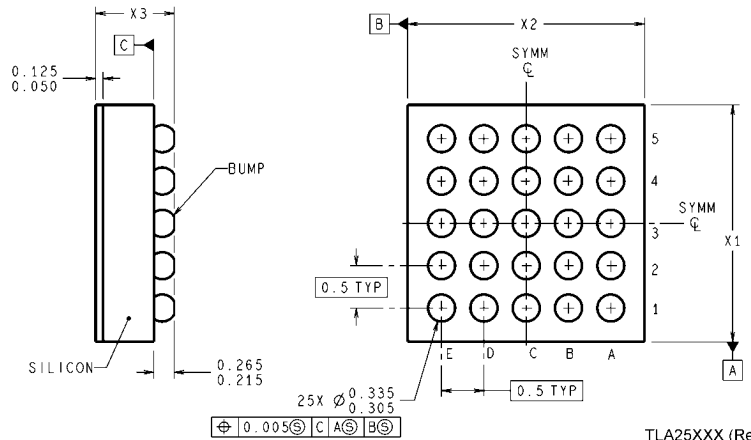

micro SMD Package
Order Number LM48520TL
NS Package Number TLA25AAA
X1 = 2.49mm, X2 = 2.49mm, X3 = 0.6mm,

Notes

LM48520

Notes

For more National Semiconductor product information and proven design tools, visit the following Web sites at:

Products		Design Support	
Amplifiers	www.national.com/amplifiers	WEBENCH	www.national.com/webench
Audio	www.national.com/audio	Analog University	www.national.com/AU
Clock Conditioners	www.national.com/timing	App Notes	www.national.com/appnotes
Data Converters	www.national.com/adc	Distributors	www.national.com/contacts
Displays	www.national.com/displays	Green Compliance	www.national.com/quality/green
Ethernet	www.national.com/ethernet	Packaging	www.national.com/packaging
Interface	www.national.com/interface	Quality and Reliability	www.national.com/quality
LVDS	www.national.com/lvds	Reference Designs	www.national.com/refdesigns
Power Management	www.national.com/power	Feedback	www.national.com/feedback
Switching Regulators	www.national.com/switchers		
LDOs	www.national.com/lido		
LED Lighting	www.national.com/led		
PowerWise	www.national.com/powerwise		
Serial Digital Interface (SDI)	www.national.com/sdi		
Temperature Sensors	www.national.com/tempsensors		
Wireless (PLL/VCO)	www.national.com/wireless		

THE CONTENTS OF THIS DOCUMENT ARE PROVIDED IN CONNECTION WITH NATIONAL SEMICONDUCTOR CORPORATION ("NATIONAL") PRODUCTS. NATIONAL MAKES NO REPRESENTATIONS OR WARRANTIES WITH RESPECT TO THE ACCURACY OR COMPLETENESS OF THE CONTENTS OF THIS PUBLICATION AND RESERVES THE RIGHT TO MAKE CHANGES TO SPECIFICATIONS AND PRODUCT DESCRIPTIONS AT ANY TIME WITHOUT NOTICE. NO LICENSE, WHETHER EXPRESS, IMPLIED, ARISING BY ESTOPPEL OR OTHERWISE, TO ANY INTELLECTUAL PROPERTY RIGHTS IS GRANTED BY THIS DOCUMENT.

TESTING AND OTHER QUALITY CONTROLS ARE USED TO THE EXTENT NATIONAL DEEMS NECESSARY TO SUPPORT NATIONAL'S PRODUCT WARRANTY. EXCEPT WHERE MANDATED BY GOVERNMENT REQUIREMENTS, TESTING OF ALL PARAMETERS OF EACH PRODUCT IS NOT NECESSARILY PERFORMED. NATIONAL ASSUMES NO LIABILITY FOR APPLICATIONS ASSISTANCE OR BUYER PRODUCT DESIGN. BUYERS ARE RESPONSIBLE FOR THEIR PRODUCTS AND APPLICATIONS USING NATIONAL COMPONENTS. PRIOR TO USING OR DISTRIBUTING ANY PRODUCTS THAT INCLUDE NATIONAL COMPONENTS, BUYERS SHOULD PROVIDE ADEQUATE DESIGN, TESTING AND OPERATING SAFEGUARDS.

EXCEPT AS PROVIDED IN NATIONAL'S TERMS AND CONDITIONS OF SALE FOR SUCH PRODUCTS, NATIONAL ASSUMES NO LIABILITY WHATSOEVER, AND NATIONAL DISCLAIMS ANY EXPRESS OR IMPLIED WARRANTY RELATING TO THE SALE AND/OR USE OF NATIONAL PRODUCTS INCLUDING LIABILITY OR WARRANTIES RELATING TO FITNESS FOR A PARTICULAR PURPOSE, MERCHANTABILITY, OR INFRINGEMENT OF ANY PATENT, COPYRIGHT OR OTHER INTELLECTUAL PROPERTY RIGHT.

LIFE SUPPORT POLICY

NATIONAL'S PRODUCTS ARE NOT AUTHORIZED FOR USE AS CRITICAL COMPONENTS IN LIFE SUPPORT DEVICES OR SYSTEMS WITHOUT THE EXPRESS PRIOR WRITTEN APPROVAL OF THE CHIEF EXECUTIVE OFFICER AND GENERAL COUNSEL OF NATIONAL SEMICONDUCTOR CORPORATION. As used herein:

Life support devices or systems are devices which (a) are intended for surgical implant into the body, or (b) support or sustain life and whose failure to perform when properly used in accordance with instructions for use provided in the labeling can be reasonably expected to result in a significant injury to the user. A critical component is any component in a life support device or system whose failure to perform can be reasonably expected to cause the failure of the life support device or system or to affect its safety or effectiveness.

National Semiconductor and the National Semiconductor logo are registered trademarks of National Semiconductor Corporation. All other brand or product names may be trademarks or registered trademarks of their respective holders.

Copyright© 2008 National Semiconductor Corporation

For the most current product information visit us at www.national.com



**National Semiconductor
Americas Technical
Support Center**
Email:
new.feedback@nsc.com
Tel: 1-800-272-9959

**National Semiconductor Europe
Technical Support Center**
Email: europe.support@nsc.com
German Tel: +49 (0) 180 5010 771
English Tel: +44 (0) 870 850 4288

**National Semiconductor Asia
Pacific Technical Support Center**
Email: ap.support@nsc.com

**National Semiconductor Japan
Technical Support Center**
Email: jpn.feedback@nsc.com